

1 Start Here

Quickstart Guide - Hub4T

Turn over for one-page "Ultra QuickStart" Instructions.

Please visit <http://support.ayrstone.com> for detailed instructions, videos, slide shows, and a troubleshooting guide.

Check the contents of the box:

- Hub2T
- Antenna
- Mounting Bracket
- Power Supply
- Power Cord
- (2) Ethernet Cables
- (2) Zip Ties (not shown)
- (2) Hose clamps (not shown)
- Coaxial sealing tape (not shown)

Write down the MAC address of your Hub, write it here, and keep it in a safe place:

00:CO:

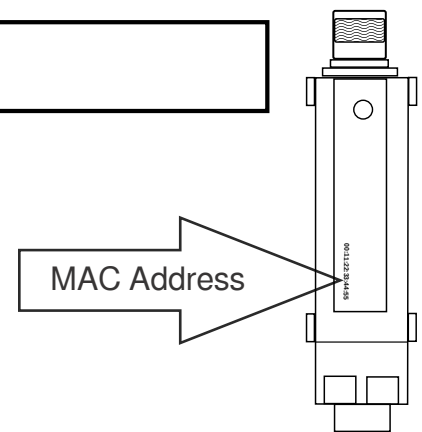

If you don't have one, sign up for an account on AyrMesh.com

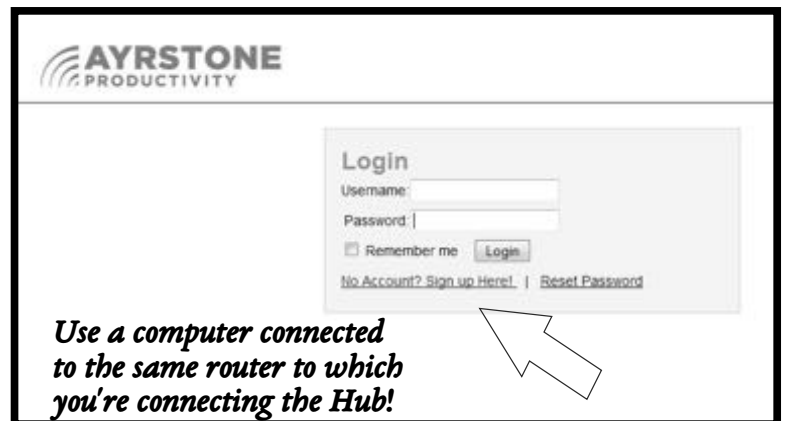
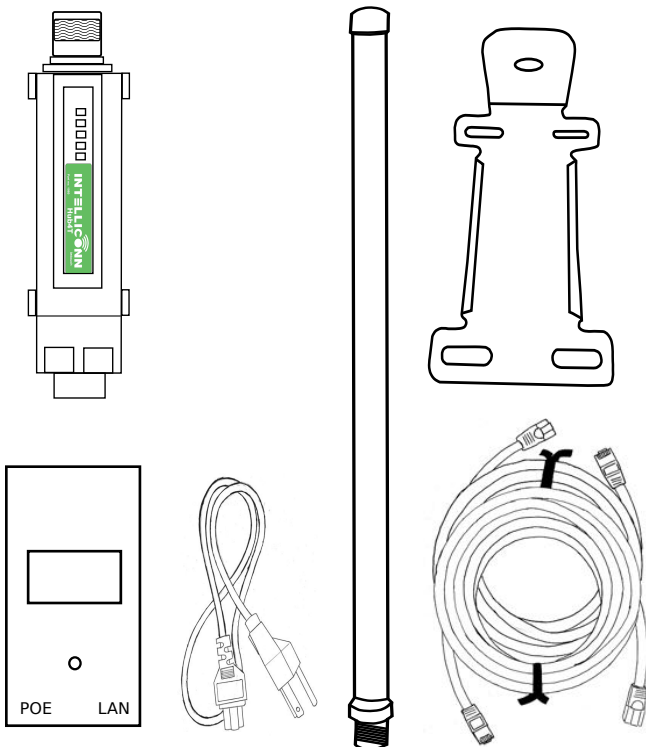

Use a computer connected to the same router to which you're connecting the Hub!

NOTE: All Hubs must be "initialized" by connecting to AyrMesh.com to download their configuration information before use.

2

Assemble the Hub and attach to router

Screw the antenna gently into the bracket...

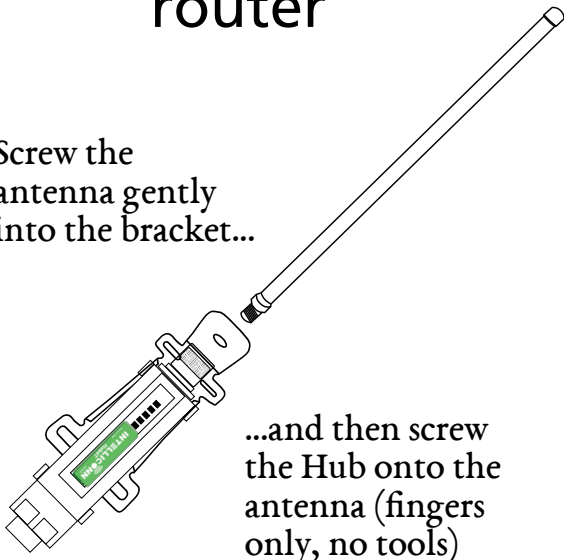

...and then screw the Hub onto the antenna (fingers only, no tools)

Unscrew the bottom of the Hub:

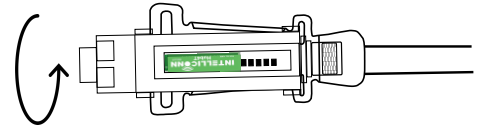

Plug an Ethernet cable into the port on the hub - slide in until it clicks in place

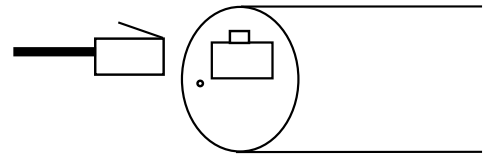

We'll leave the cover off the Hub for now.

Click the other end of the Ethernet cable into the port on the power supply marked "POE"

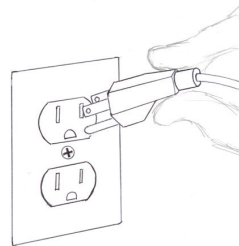
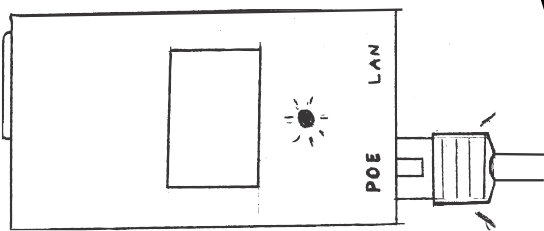

Plug in the power supply. This is how the whole thing should look:

DO NOT FORCE CABLES INTO OR OUT OF PORTS!

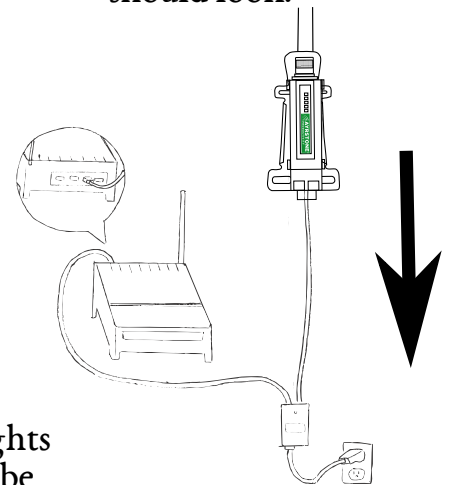

Use another Ethernet cable to connect the LAN port of the power supply to one of the LAN ports on your router.

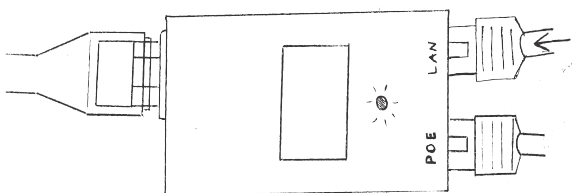

Connect the power cable to the power supply

The bottom two lights on the Hub should be lit up:

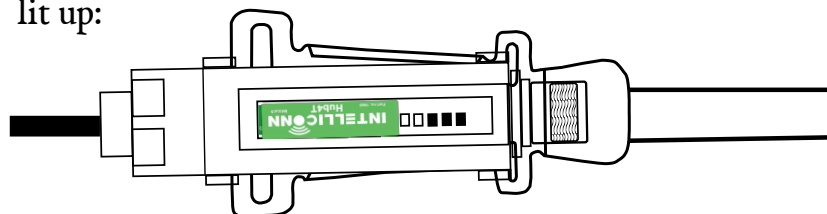

Make sure you have an account on AyrMesh.com

3

Make sure the Hub is working

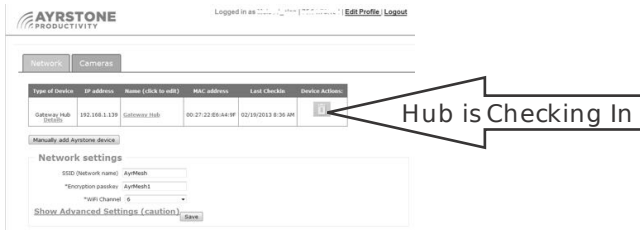

The signal lights (4 top lights) will start out "running" from bottom to top. When the Hub has checked in to AyrMesh.com, just the top signal light will be on.

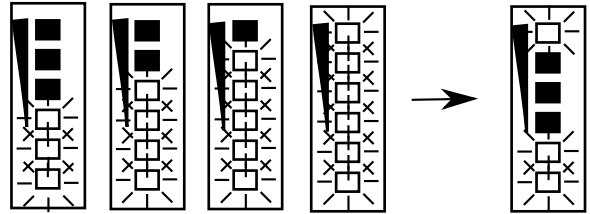

It usually takes about 1-2 minutes for the Hub to check in and show up on AyrMesh.com, but sometimes it can take a little longer.

4

Finish the Installation

All Hubs should be mounted outside, up as high as possible, with the antenna pointing straight up.

Maximum range for the Hub depends on having clear line-of-sight.

The Hubs can be mounted to a flat surface with four screws, or to a pole with the included zip ties or pipe clamps.

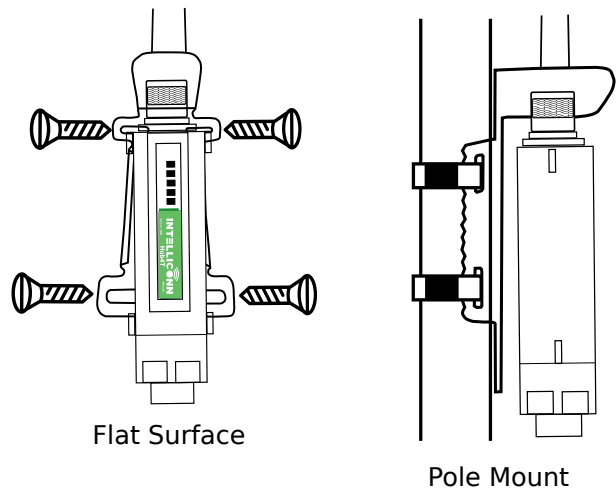

To be weather-tight, the bottom gland and cover must be installed. To do that, remove the gland from the cover:

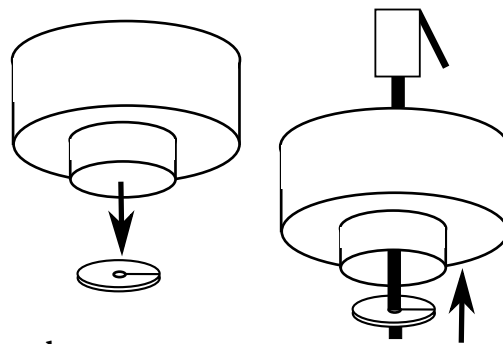

Slip the gland onto the Ethernet cable using the slit in the gland, then push the cable through the hole in the cover. Push the gland back into the cover, then screw the cover back onto the Hub.

5 Signal Lights on the Hub

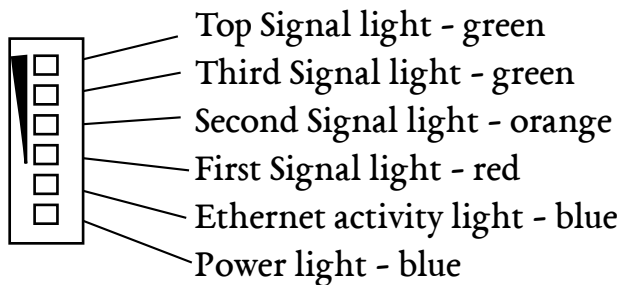

Gateway Hubs have the following lights on:

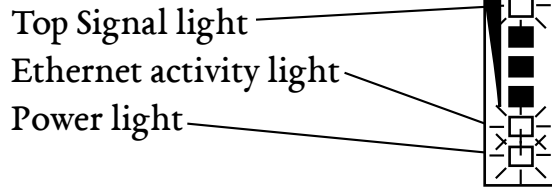

Remote Hubs use the signal lights to show the signal strength to the nearest Hub. The signal strength is exhibited as follows:

- Just the first (red) signal light - very low signal
- First and second (yellow) light - good signal
- First, second, third (green) light - excellent
- All 4 signal lights - Hubs may be too close

The signal lights on a Remote Hub are refreshed approximately once per second.

6 Using the AyrMesh Hub

To access the Hub's WiFi Access Point:

- Click on the Wireless icon on your computer, or select the WiFi settings on your tablet or smartphone
- Select the AyrMesh network from the list of available WiFi Access Points (default "AyrMesh" unless changed in AyrMesh.com)
- Enter the Encryption Passkey when prompted - default is "Aymeshr" (note the capital "A")

NOTE: Once you have tested the Hub, **MAKE SURE** you **CHANGE THE ENCRYPTION PASKEY** (and SSID if desired) on AyrMesh.com to ensure the security of your network.

Note that changes on AyrMesh.com may take half an hour or more to take effect. The Hubs wait to make sure all the devices on your network receive the new configuration.



Wireless network selection in Windows

Select AyrMesh

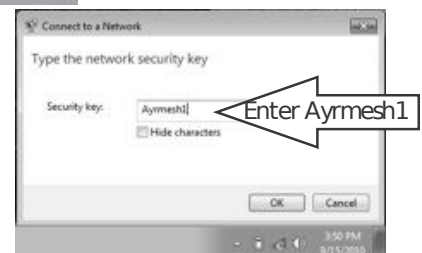

7 Troubleshooting

Gateway Hub:

- Ethernet Light does not come on, or Hub does not appear in router's DHCP table, or Hub never checks in to AyrMesh.com
- Check all cables between router and Hub
- Ethernet Light comes on, Hub appears in router's DHCP table, but Hub does not check in to AyrMesh.com
- Add Hub's MAC address to your AyrMesh.com account manually

Remote Hub:

- Signal lights do not come on
- Make sure Hub was initialized by plugging into router
- Network slow, only bottom (red) signal light on
- Low signal strength - put Hubs higher and ensure good line-of-sight between them
- Network slow, all signal lights on
- Hubs may be too close together - re-think placement of Remote Hubs

NOTE: To prevent water damage, make sure the Hub is mounted with its antenna pointing straight up and that the Ethernet cable has a "drip loop" where it enters any building.

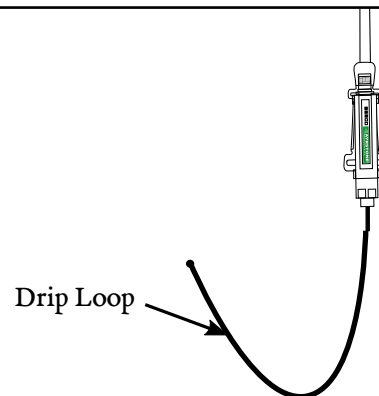

See <http://ayrstone.com/support> for additional information, hints, and troubleshooting tips.

ULTRA-QUICKSTART GUIDE

These directions are minimized for more knowledgeable/experienced installers. For the "regular" Quickstart instructions, turn these directions over. For more detailed instructions, please see <https://support/ayrstone.com>

1

GET READY: Write down the MAC address of the Hub and put it someplace safe. If you haven't already, create an account on AyrMesh.com from a computer connected to the same router that the Hub will be connected to. This ensures you won't have to enter the Hub's MAC address manually. If you create the account from a different IP address (e.g. from your phone connected to the cellular network) then enter the IP address in your AyrMesh.com account.

MAC Addr: 00:C0:

2

ASSEMBLE: Screw the antenna into the mounting bracket (finger-tight, no tools), then screw the Hub onto the bottom of the antenna (again, finger-tight). Unscrew the cap on the bottom of the Hub, exposing the Ethernet port.

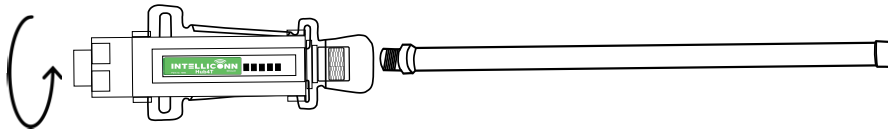

3

INITIALIZE: With an Ethernet cable, connect the LAN port of the Power Supply to your router. With another Ethernet cable, connect the PoE port of the Power Supply to the Hub. Plug in the power supply (lights on the Hub will go on). Wait until the Hub checks in to AyrMesh.com - the signal lights will "run" from bottom to top, then the top signal light will remain lit. This should take about a minute.

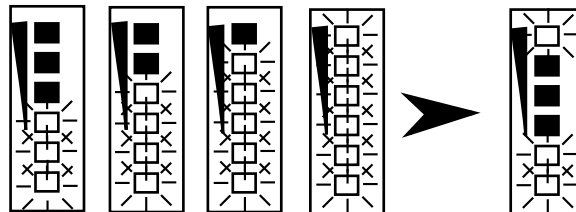
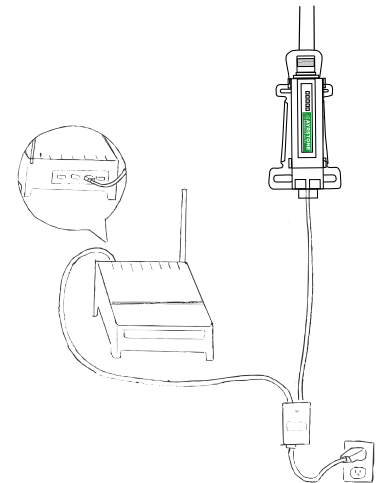

4

INSTALL: Mount the Hub outdoors, as high and "in the clear" as possible. Run a long (preferably shielded - STP) Ethernet cable from the power supply (which must be kept dry) to the Hub - remember to leave a "drip loop" where the cable enters the building to prevent water from coming down the cable inside. The Gateway Hub must have the "LAN" port of the power supply connected to the Router; Remote Hubs have the LAN port available for connecting other devices.

Thread the end cap onto the Ethernet cable, then slide the "gland" onto the cable and press it into the end to make it weather-tight.

